

SHELL.NANO

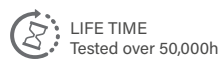
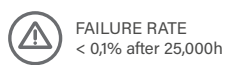

CIRCULAR PROJECTORS
SHELL SERIES

References

Code	Type	Finish	Light Color	Power	Lense		Voltage	Driver	
VL-SH.NANO	A Base F Nut	LG Light grey	White	3W	20°	30°	12 12Vdc	STD ON/OFF	
		DK Dark grey	W24 2400K						40°
	WH White	W27 2700K	25x45°		24 12Vdc	R010 Remote 0-10V			
	BK Black	W30 3000K							
	RAL Any RAL color	W40 4000K					RD Remote DALI		
		W60 6000K							RCAS Casambi
				Single Color (SC)					
			R Red		3W	20°	30°	12 12Vdc	STD ON/OFF
			B Blue			40°	60°		R010 Remote 0-10V
			G Green			25x45°		24 12Vdc	RD Remote DALI
		A Amber						RCAS Casambi	

Reference example

VL-SH.NANO-A-WH-W24-3W-60°-24-STD

Variations



A
Base



F
Nut (M10x1,5mm)

Dimensions

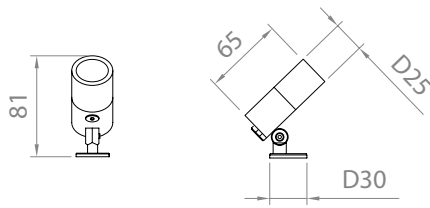

TYPE A

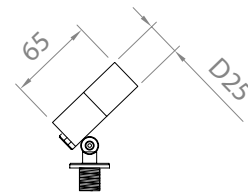

TYPE F

Accessories

Code	Accessories
VL-SH.NANO	HC Honeycomb Grid HO Hood 48 mm

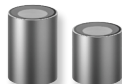
Code	Accessories
VL-SH.NANO	*SPK SPIKE *BX Elevated Box *POLE POLE *CLP CLAMP *STR STRIPE *CBLX Special length cable

** Must be used with Type F*
** Must be used with Type F*
** Must be used with Type F*
** Must be used with Type F*
** Must be used with Type F*

** Instead of X, put length of cable needed*
Example: VL-SH.NANO-CBL-10m

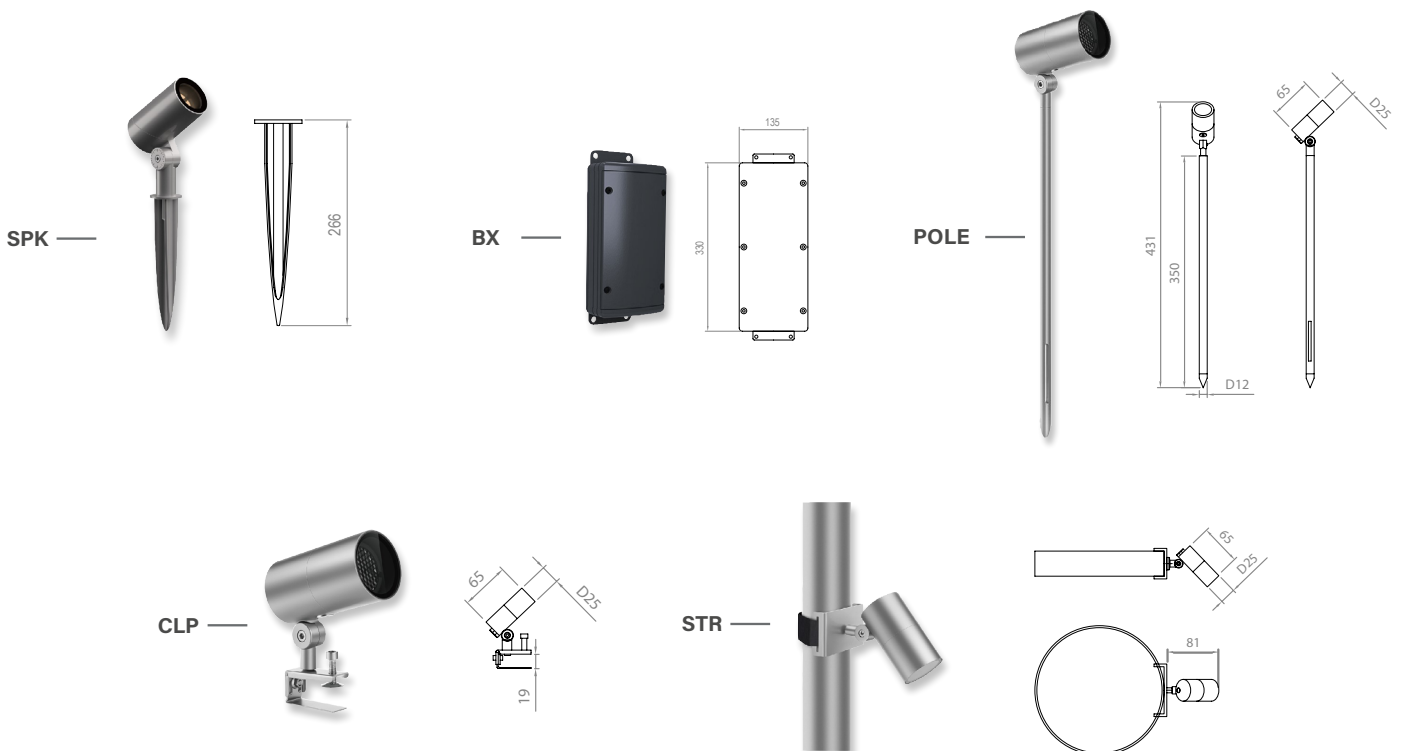

Accessories

Code	Description	Diameter	N° of projectors
------	-------------	----------	------------------

VL-SH.NANO

RNG RING

50 50cm
60 60cm
70 70cm
80 80cm

2P 2 projectors
3P 3 projectors
4P 4 projectors
6P 6 projectors
8P 8 projectors

Suggested diameter = diameter of tree trunk + 10cm/15cm

** projectors references must be order separetly*

*** For 24Vdc projectors, ring can allocate 1 power supply for all projectors*

**** Must be used with Type F*

